

DIGITAL ANGLE WRENCH

MODEL CTA2-G

INSTRUCTION MANUAL



To the user

In order to use the torque wrench properly and safely, please read this instructions before operation. If any question, please contact a Tohnichi authorized distributor or Tohnichi office. Keep this operating instruction for future use.



Use only a dedicated charger and storage battery.

Do not use any other chargers or storage batteries not designated on this manual.

Charge correctly. Please use the charger only listed in this manual.

- It may generate unusual heat and cause fire.

Do not charge the battery at temperature below zero, or above 40 degree Celsius.

- It may cause burst of battery or fire.

Please charge a storage battery in a well ventilated place.

Please do not cover a charger or a storage battery with cloth, etc.

- It may cause burst of battery or fire.

When not using the charger, take the plug off the outlet to avoid electric shock or fire.

Please pay attention to the surrounding conditions or environment.

Do not use the main wrench, the charger and the battery in rain, or at wet condition.

- It may cause an electric shock or fire.

Keep the work place well lit to avoid accidents.

- Using it in a dark place may cause accidents.

Do not use or charge in a place where inflammable liquid and gas exist.

- It may cause explosion or fire.

Use the designated accessories only. As a basic rule, do not use any items not directed in this instruction manual.

- It may cause explosion or injuries.

Do not throw the batteries in fire.

- It may burst or generate hazardous substance.

Cautions

(1) Keep the working place clean and tidy.

Working in a messy condition may cause accidents.

(2) Keep children away from the product or the work place.

As a basic rule, do not let any other person than the user himself should touch the product. It may cause injuries.

(3) When not in use, keep them in a safe place.

Storage place should be in dry condition where it is securely locked and away from children.

It may cause injuries.

Do not keep the main wrench or the battery in a environment where the temperature may exceed 50 degree Celsius.

It may lead to the deterioration of the battery and cause fire.

(4) Do not force this product to use beyond its capacity.

In order to use it safely and efficiently, use this product within the designated torque range.

Using the product beyond its capacity may cause accidents.

(5) Use this product to fit work.

Do not use this product for any other purpose than the instructed usage.

It may cause injuries.

(6) Do not handle the battery cord roughly.

Do not carry a battery by the cord or take it off the electric outlet by pulling the cord.

Do not expose the cord to head, oil, or any place where it could be damaged.

It may cause electric shock or fire.

(7) Always brace yourself and maintain balance when working.

Be careful not to slip and fall, which may cause injuries.

(8) Do maintenance work carefully.

For part replacement, refer to the instruction manual.

Doing otherwise may cause injuries.

Conduct periodic check on the cord of the charger, and request repair or replacement to the authorized distributor or Tohnichi if damaged.

If you keep using the damaged cord, it may cause electric shock, or fire.

If you intend to use an extension cord, conduct the periodic check and replace it if damaged.

Otherwise, it may causes short-circuit or fire.

Keep the handle part of the wrench clean and dry. Protect it from oil or grease.

Otherwise, it may cause the handle to slip and lead to injuries.

(9) Conduct periodic checking to detect damaged part.

If you find any damaged part such as the plug or cord, request repair or replacement to the authorized distributor or Tohnichi.

If you keep using the damaged ones, it may cause short-circuit or fire.

Note:

- (1) Use the dedicated battery and battery charger only and do not use any others.
- (2) Do not apply any vibration or physical impact on the product.
- (3) Do not use this product in conditions not instructed in this manual.
- (4) Check the setting and conditions before use.
- (5) Protect this product from water or oil to avoid breakdown.
- (6) Do not drop this product.
- (7) Use the product within the capacity instructed in this manual.
- (8) Conduct periodic check on the product.
- (9) Make zero adjustment before use.
- (10) Hold the handle on the effective length line and apply force at right angle to the torque wrench.

If you should find any irregular performance of the product, stop using the product immediately and keep it in a safe place. Contact Tohnichi immediately.

Explanation of words

Please refer to the below explanation of words which are used in this operation manuals.

- **Tightening mode:** Tightening mode includes single-spindle tightening mode and production tightening mode. Tightening modes should be selected according to the user conditions. Single-spindle tightening mode is selected at default setting (delivery setting).

- **Single-spindle tightening mode:** This mode should be applied when you are working on a single bolt condition (snug torque, tightening angle) by the angle tightening method. Upon reaching the set angle after passing the snug torque, a buzzer goes off and LED lights up.

- **Production tightening mode:** This mode should be applied when you are working on more than 2-bolt condition by the angle tightening method. It needs to set a tightening torque, snug torque, 1st, 2nd, and 3rd angle and the number of bolts. Applicable for tightening operation in production lines.

- **RUN mode:** With this mode, the display shows the value (torque/angle) which is applied at the moment continuously. The displayed torque value increase as you apply loading and decrease to zero as you release loading. The displayed angle value count up (+) as you rotate clockwise, and count down (-) as you rotate counter-clockwise. This modes should be applied when calibrating for torque or angle.

- **PEAK mode:** With this mode, the maximum value (torque or angle) will be captured and remain on the display after releasing the loading. The maximum angle value will be captures only after passing the snug torque.

- **Tightening stage:** It refers to each tightening stage when tightening by the production tightening mode(= torque tightening stage, 1st angle tightening stage, 2nd angle tightening stage, 3rd angle tightening stage.)

- **Snug torque (setting):** This is the torque from which angle tightening count starts. Torque tightening should be applied up to the snug torque, and the angle counting starts thereafter.

- **Tightening torque (setting):** This is the tightening torque value to set at the torque tightening stage in the production tightening mode. After passing this torque, the operator will be informed by the blue LED and the buzzer. When it goes over the upper limit, the red LED lights up and another buzzer goes off to alarm the operator.

- **Tightening angle (setting):** Tightening angle to set in the single-spindle tightening mode. After passing the snug torque, angle counting starts. Upon reaching the set angle, the blue LED lights up and the buzzer goes off. When it goes over the upper limit, the red LED turns on and another buzzer goes off to alarm the operator.

- **1st (2nd, 3rd) tightening angle (setting):** Tightening angles to be set at each angle tightening stage in production tightening mode. After passing the snug torque, angle counting starts. When it passes the 1st torque (2nd torque, 3rd torque), the blue LED turns on the buzzer goes off. When it goes over the upper limit value, the red LED turns on and another buzzer goes off to alarm the operator.

- **Number of bolts (setting):** It is the number of bolts to set in the production tightening mode.

- **Memory counter:** It is the counting number of the measured data. In the single-spindle tightening mode, the counting number goes up each time it saves 1 bolt tightening data. In the production tightening mode, the counting number goes up each time 1 cycle of tightening stages completes.

- **Spindle counter:** In the production tightening mode, this counter goes up each time tightening of 1 spindle completes. After completing the set number of bolts, it resets as it proceeds to the next tightening stage.

Contents

1. Outline
2. Usage and features of each tightening mode
3. Composition
4. Basic operation flow
5. Name and explanation of each part
6. Various functions
7. How to use
 - Single-spindle tightening mode
 - (1) Basic operation and display
 - (2) Torque/Angle calibration method
 - (3) Tightening operation (example)
 - (4) Displaying the measured data
 - (5) Outputting the measured data
 - (6) Deleting the measured data
 - Production tightening mode
 - (1) Basic cooperation and display
 - (2) Torque/Angle calibration method
 - (3) Tightening operation: Example 1
 - (4) Tightening operation: Example 2
 - (5) Reading the measured data
 - (6) Output/Delete the measured data
8. Various settings (using the key operation on CTA2-G)
 - Single-spindle tightening mode
 - Production tightening mode
9. Various settings (using the application software)
10. Transferring the tightening data to PC
 - In case of Single-spindle tightening mode
 - In case of Production tightening mode
11. External output
12. Battery
13. Charging
14. Options
15. Specifications

1. Outline

CTA2-G is a digital torque & angle wrench designed for use in the angle tightening method. 2 tightening modes are available as Single Spindle Tightening mode, and Production Tightening Mode. In Single Spindle tightening mode, snug torque, tightening angle and tightening angle upper limit are to be set, and the operator is informed upon reaching the set angle (after passing the snug torque) by the blue LED and the buzzer. In Production tightening mode, tightening torque, snug torque, 1st, 2nd and 3rd tightening angle and the number of spindles are to be registered in order to process tightening in production line efficiently. By using the packaged application software (CD), various setting can be done through PC.

2. Usage and features of each tightening mode

- Single-spindle tightening mode

Usage

- For angle method tightening of a single angle setting
- For redoing tightening operation.
- For experiment and study purpose

Features

- The tightened angles will be judged OK/NG against the allowable range to detect tightening errors.
- Max. 999 readings can be saved (tightened torque, tightened angle, tightened date and time).

- Production tightening mode

Usage

- For production line.
- Applicable for work with more than 2 spindles are to be tightened by the angle tightening method.
- Applicable when it is required to tighten for the torque tightening stage, and 1st /2nd/3rd tightening stage continuously.

Features

- The tightened angles will be judged OK/NG against the allowable range to detect tightening errors.
- Tightening stage will be shown on the display in the registered order, therefore, human errors can be avoided (Pokayoke function).
- Measured data for max. 999 spindles (tightening torque, 1st/2nd/3rd tightening angle, final tightening torque, tightening date and time) can be saved.

* You can select the mode (single-spindle tightening mode/production tightening mode) through the application CD on PC or the key operation on the wrench itself (refer to **8. Various settings** for details).

3. Composition

- Main body	1 pc
- Accessories	
Battery Pack BP-5	1 pc
Interchangeable head QH	1 pc
Battery charger	1 pc
Application CD	1 pc
Communication cable #584 (CTA2-G - USB)	1 pc
- Operating instruction manual	each 1 pc for ENG/JP

4. Basic operation flow

1. Set the enclosed battery pack and the interchangeable head QH and the socket to CTA2-G (sockets are for separate sale).
2. Install the packaged application software CD and the USB driver to PC.
3. Connect CTA2-G to PC by the communication cable #584 (enclosed) and make settings to your preference (setting by manual key operation is also available).
4. Conduct tightening and save data
5. Transfer the measured data to PC to save.

* For detailed instructions on installing the application software and its usage, refer to the instruction manual enclosed inside the enclosed CD.

Installation of battery

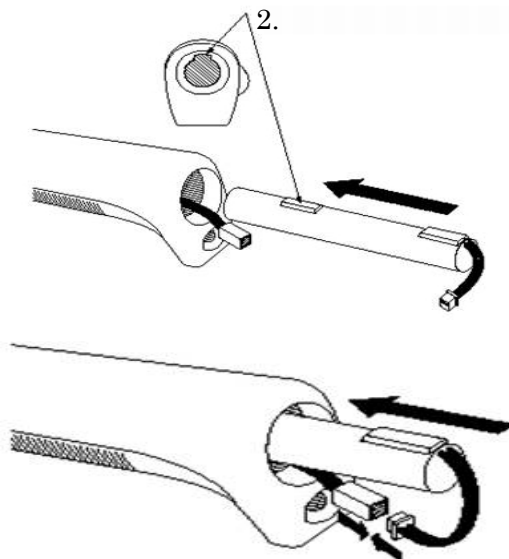

1. Rotate the cap clockwise to open it.
2. Follow the below illustration to slide it in.
3. Connect the connector.
4. Push in the battery to the end.
5. Push in the cable and the connector inside.
6. Put the cap on by rotating it counter-clockwise.

Caution) When putting the cap on, be careful not to damage the cable and connector.

5. Name and explanation of each part

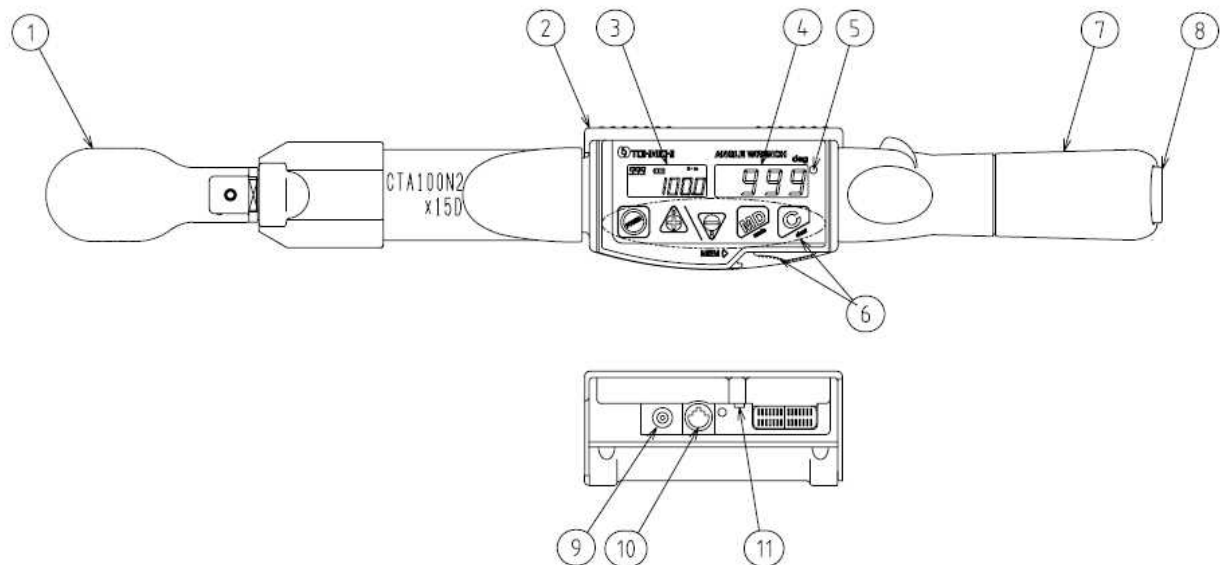

1. **Interchangeable head:** QH is packaged as standard accessory. Other TOHNICHI interchangeable heads are also applicable (SH, SH-N, RH, QH, RQH, DH, HH, FH).
* PH head cannot be used.
2. **Protection cover:** it is to protect from physical damage to CTA2-G against work applications.
3. **LCD display:** To display memory counter, torque value, torque unit, remaining battery indication.
4. **7-segment LED display:** To display tightening angle.
5. **Tightening completion / judgment LED:** It turns blue for OK and red for NG.
6. **Operation key:** To operate power key, ▲ (forward) key, ▼ (backward) key, MD (mode) key, C (clear) key, MEM (memory) key to make settings. (Refer to 7. How to use).
7. **Handle:** To set battery pack (BP-5) inside.
8. **Cap:** Remove this cap to exchange battery backs (rotate counter-clockwise to open)
9. **Recharging jack:** The output terminal to connect to Quick Charger BC-3.
10. **External output terminal:** The output terminal to connect USB cable.
11. **Reset switch:** Use this switch in case of display error and operation error. Not necessary to push this switch each time after recharging (This is to be used when changing setting values or RUN mode in the production tightening mode).

6. Various functions

1. Auto Zero function (torque)

In RUN mode, it will be automatically adjusted to zero by pushing Clear key.
 (Auto Zero function is applicable only when the torque load is within 7.5% of the max range). If the loaded torque is over 7.5%, the display shows “Err9”.
 In case of Err9, refer to ③ Error message.

2. Angle speed check / zero adjustment function

When turning on the power, angle speed check will be automatically conducted to make zero adjustment. During zero adjustment, CTA2-G should be put still (do not move) otherwise the display may show “Err0”. The angle speed check will also be automatically processed when it is in still kept still for more than 2 seconds.
 In case of Err0, refer to ③ Error message.

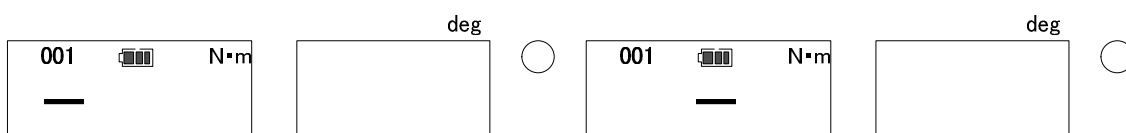

During angle speed check, the display shows” —“.

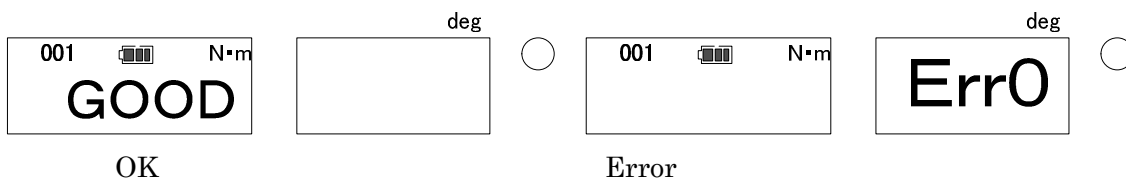

3. Error message

Error messages will appear on the display when there is some error during 1 or 2 process.

<< Err 0 >>

Error in angle speed detection.

- ◎ Turn off the power once. Keep the body still (no movement) and turn on the power again.
- If Err disappears, then it operates normally.
- If Err message remains on the display, contact TOHNICHI or the nearest distributor to ask for repair.

<< Err 1 to 5 >>

Error in MEMBRANE switch.

- ◎ Turn off the power once and turn it on again without touching any keys.
 - If Err disappears, then it operates normally.
 - If Err message remains on the display, contact TOHNICHI or the nearest distributor to ask for repair.

<< Err 8 >>

Error in data memory.

- Contact TOHNICHI or the nearest distributor to ask for repair.

<< Err 9 >>

Error in the circuit board or the torque sensor.

- ◎ At no load condition, press Clear key.
 - If Err9 disappears, it operates normally.
 - If Err message remains on the display, contact to TOHNICHI or the nearest distributor to ask for repair.

4. Auto memory/Reset function

After angle tightening, tightened value is automatically saved and forward to the counter to the next. Auto memory timing can be selected from 0.1 – 5 seconds.

If you do not want to use auto memory function, set it as 0.0 second.

5. OK/NG judgment function

It judges whether the measured value is within the set range (upper limit and lower limit). After measurement, OK/NG judgment will be conducted by pressing the memory key. Judgment will be informed by blue and red LED. When auto memory/reset is set, judgment will be conducted automatically.

6. Mute setting

By setting “OFF” on buzzer output setting, the buzzer sound on key operation will be turned off. However, over-torque alarm, tightening completion, NG judgment alarm remains effective.

7. Electric power saving

When it is left without any key operation of tightening operation for about 1min.

7-segment LED darkens to save electricity. This mode is available when auto power off is set ON.

8. Auto power off

When it is left without any key operation of tightening operation for a set time (default setting is 3 min.) or unloading condition (loading torque is 7.5 % less than the max. torque range of the model), the power will automatically turn off.

If you prefer not to use auto power off, set it to OFF. At "LoBATT" alarm condition, power will turn off in 1 minute regardless of the above condition.

9. Residual battery indicator

Residual battery amount is indicated on the display as follows:



Enough battery remains.



About half the battery is gone.

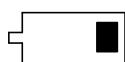

It is about time to recharge.

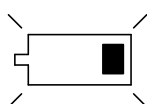

"LoBATT" alarm condition

No battery available. Recharge immediately.

blinking

The display shows "LoBATT" and no key operation will be effective except Power switch.

Power will be OFF automatically after about 1 minute.

Saved data of measurement will not be deleted even if the battery is gone.

9. Over-torque alarm

When it exceeds 105% of the maximum measurable torque, the value on the display and "----" blinks alternatively and the buzzer goes off.

10. Over-torque alarm/Peak torque hold starting value for each CTA2-G models.

(N · m case)

MODEL	TORQUE RANGE		1 digit	From 105% of MAX torque	From 3.3% of MAX measured torque	Auto zero range (7.5 % of MAX torque)
	MIN.	MAX.		Over-torque alarm	Peak hold starting torque	
CTA50N2X12D-G	(2.5)10	50	0.05	52.50	1.67	3.75
CTA100N2X15D-G	(5)20	100	0.1	105.0	3.3	7.5
CTA200N2X19D-G	(10)40	200	0.2	210.0	6.7	15.0
CTA360N2X22D-G	(18)72	360	0.4	378.0	12.0	27.0
CTA500N2X22D-G	(25)100	500	0.5	525.0	16.7	37.5
CTA850N2X32D-G	(43)170	850	1	893	28	64

* Values in () is the min. setting value of snug torque.

* Accuracy for the snug torque set below the min. torque value cannot be guaranteed.

7. How to use

○ Single-spindle tightening mode (MODE-S, original CTA function)

(1) Basic operation and display

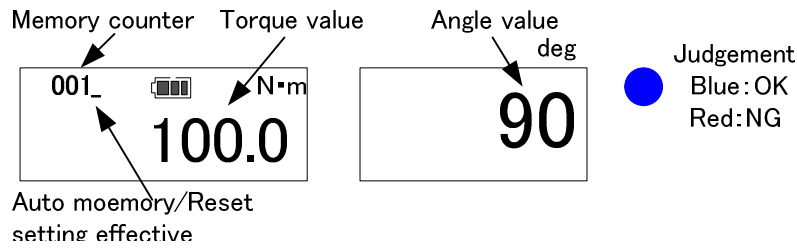

▲ Counter Send Key: Sends a counter one by one or continuously to read out measured data. Keep it pressed to send it by 10 (fast-forward).

▼ Counter Return Key: Reverses one counter or continuously to read out measured data. Keep it pressed to send it by 10 (fast-forward)

MD Key: Press this key at PEAK mode to set it for external output.
Keep it pressed at RUN mode to set it for setting input.

MEM key: Saves the measured data and send the counter by one.

C key: Clears the measured data.

POWER key: Turn ON/OFF the power.

When it turns on, it conducts the angle speed check automatically, therefore, keep it still for more than 1 second.

(2) Torque/Angle calibration method

Set the counter to 000 by ▲▼ key to set it to RUN mode.

Use a torque wrench tester for torque calibration, and the angle calibration machine for angle calibration.

(3) Tightening operation (example)

Below instructions show an operation flow for tightening at the following values.

Snug torque	30 N·m
Tightening angle setting	90 deg
Tightening angle upper limit	95 deg

Tighten up to the snug torque.

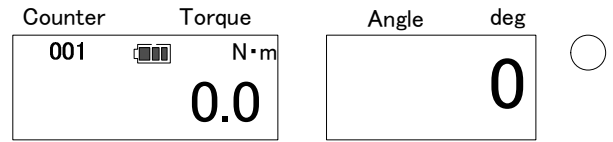

Upon reaching the snug torque, the buzzer goes off for 0.5 seconds and the angle measurement starts.

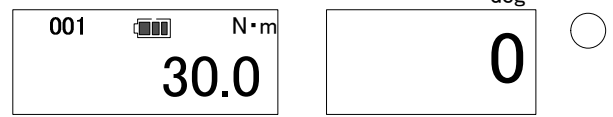

When it reaches 20 degrees before the set angle, the buzzer starts to sound on and off continuously (the buzzer will not sound if the set angle is below 20 degrees).

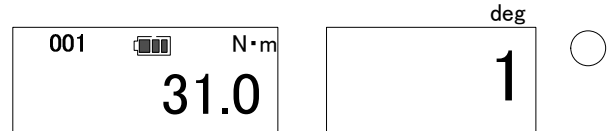

Upon reaching the set tightening angle, the buzzer goes off and the blue LED turns on.

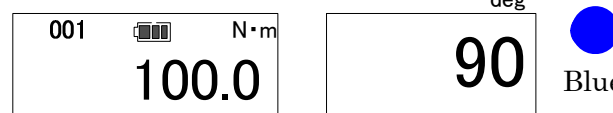
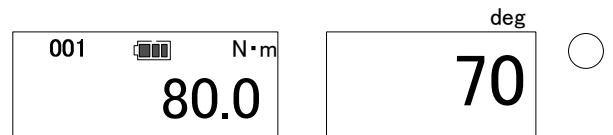

If tightening exceeds the upper limit, another buzzer goes off and red LED turns on.

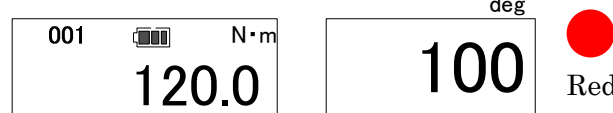

Blue
Red
Blink

After releasing loading, press MEM key to make judgment to see whether the tightened torque/angle is within set range (The judgment is conducted automatically when auto memory/reset is set).

- In case of OK: It saves the measured data and proceed to the next counter.
- In case of NG: It inform by the buzzer alarming and the red LED.

Press MEM key again to save this measured data and proceed to the next counter.

If you would like to delete the data, press C key.

(4) Displaying the measured data

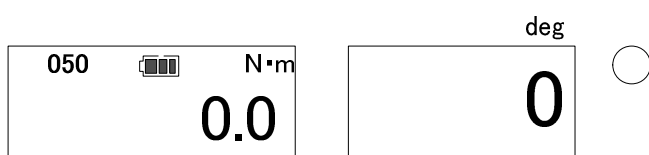

Press ▼ key to reverse the memory counter to check the previous measured data.

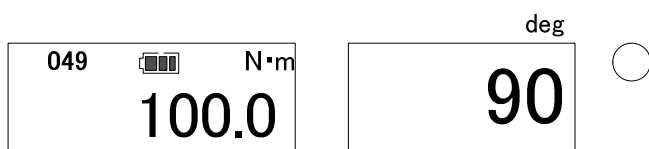

When the memory counter is 001, press ▼ key one more time to set it 000, then it becomes the RUN mode.

When the memory counter is 000, press ▼ key one more time, then the memory counter goes to 999 and the measured data will be shown accordingly.

(5) Outputting the measured data

● Data output (1 reading)

Use the dedicated communication cable to connect CTA2-G to PC or printer.

Use ▲▼ key to show the data to output and press MEM key to transfer.

● Data output (a set range of data at one time)

Use the dedicated communication cable to connect CTA2-G to PC or printer and set the memory counter to the upper limit of the output data range to transfer.

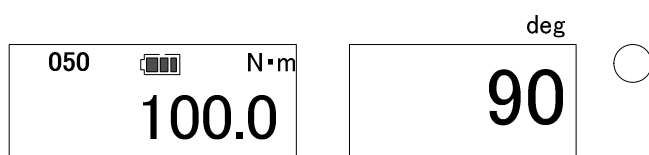

Press MD key to confirm the upper limit, then the display proceed to the lower limit setting.



Use ▲▼ key to set the lower limit of the output data range. Press MD to confirm the lower limit and the display shows the number data to transfer (Press C key to cancel).

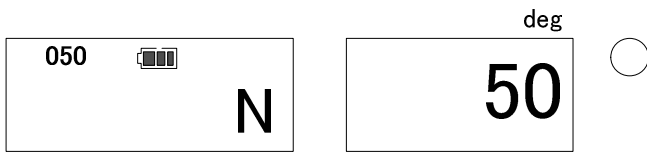

Press MEM key to output the set range of data all at the same time (Press C to cancel).

(6) Deleting the measured data

● Deleting 1 data

Use ▲▼ key to show the data to delete and press C key to delete.

● Deleting a set range of data

Use ▲▼ key to show the upper limit of the data range to delete.

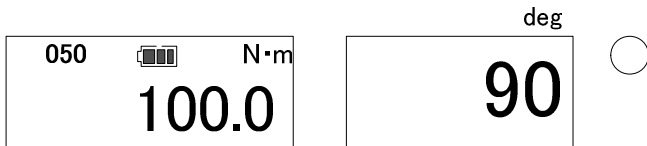

Press MD to confirm the upper limit, then the display proceed to the lower limit setting.



Use ▲▼ key to show the lower limit of the data range to delete, and press MD. The Display shows the number of data to delete (Press C to cancel).



Keep MD key pressed and press C at the same time, then the set range of data will be deleted all at once and return to measuring mode.

○ Production tightening mode (MODE-P)

(1) Basic operation and display

● RUN mode (memory counter: 000)

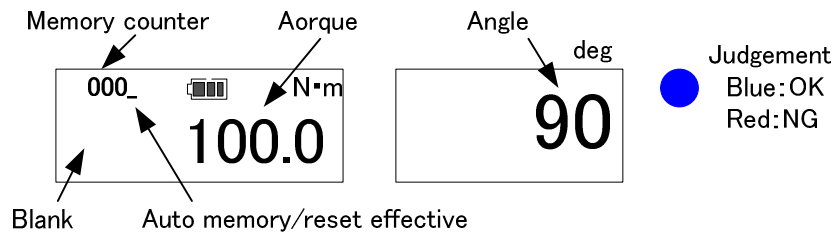

Press the reset switch or unplug the discharge plug to reset and it starts in RUN mode.

● PEAK mode (memory counter: 001~999)

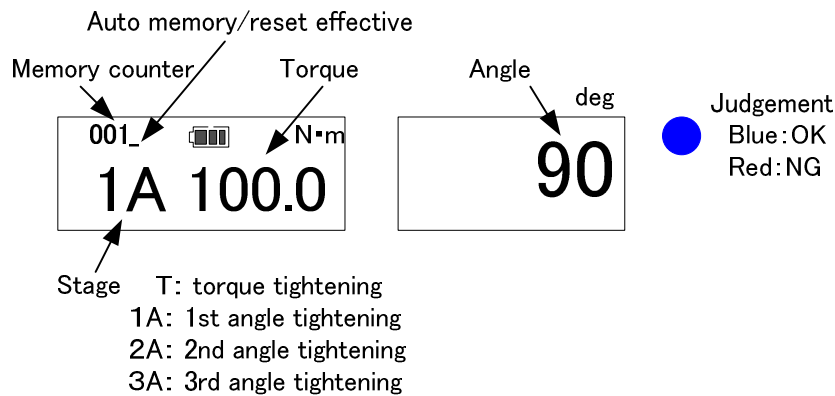

▲ key: Use this key to change setting digit in setting.

▼ key: Use this key to lower the value in setting.

MD key: Press this key in the tightening mode, then it changes to external output display

Keep this key pressed in RUN mode to change to setting mode.

MEM key: Saves the measured data and proceed to the next.

If you press this key in RUN mode, then it changes to the measurement mode.

C key: Deletes the measured data.

POWER key: Turn ON/OFF the power. When it turns ON, it conducts the angle speed check.

(2) Torque/Angle calibration method

Press reset key (or plug in the charger plug and unplug it) to set it to RUN mode.

Use a torque wrench tester for torque calibration, and the angle calibration machine for angle calibration.

(3) Tightening operation: Example 1 (Torque tightening stage + 1st/2nd angle tightening stage, NG RES)

Below instructions shows an operation flow for tightening at the following values.

Tightening torque	30 N·m	2nd tightening angle upper limit	95 deg
Tightening torque upper limit	35 N·m	3rd tightening angle	0
Snug torque	30 deg	3rd tightening angle upper limit	0
1st tightening angle	90 deg	Number of spindle	5 pc
1st tightening angle upper limit	95 deg	NG setting	NG_RES
2nd tightening angle	90 deg		

Operation Flow

Torque tightening stage (5 spindles) → 1st angle tightening stage (5 spindles) → 2nd angle tightening stage (5 spindles) After completing tightening of all the stages, it output data and proceeds to the next work.

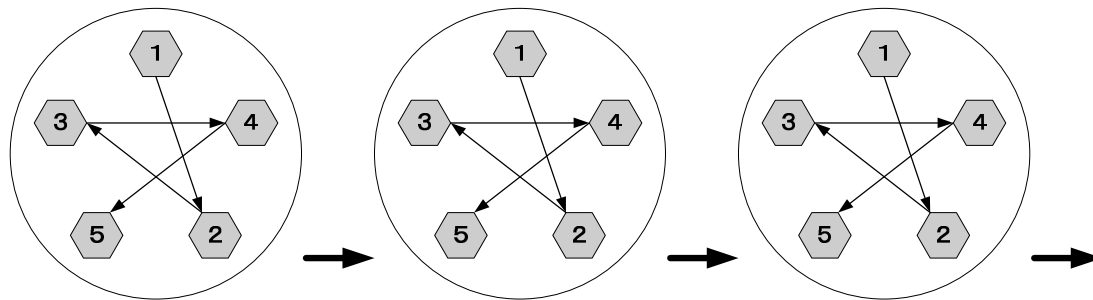

Torque tightening stage 1st angle tightening stage 2nd angle tightening stage
Completion

Tightening order

Torque tightening stage: Spindle① → Spindle② → Spindle③ → Spindle④
→ Spindle⑤ →

1st angle tightening stage: Spindle① → Spindle② → Spindle③ → Spindle④
→ Spindle⑤ →

2nd angle tightening stage: Spindle① → Spindle② → Spindle③ → Spindle④
→ Spindle⑤

All stage complete (data output) → Proceed to the next work

NG setting explanation

“NG_RES”: When the judgment is NG, press MEM key to saves the data and proceed to the next spindle.

“ALLRES”: When the judgment is NG, press MEM key to save the data. The memory counter will be renewed and start from the beginning stage.

* In both cases, press C key to delete the data.

Operation and display

● Torque tightening stage

Tighten the 1st spindle.

Upon reaching the set torque, the buzzer goes off for about 1sec and the blue LED turns on.

When the tightened torque exceeds the upper limit, another buzzer goes off and the red LED turns on.

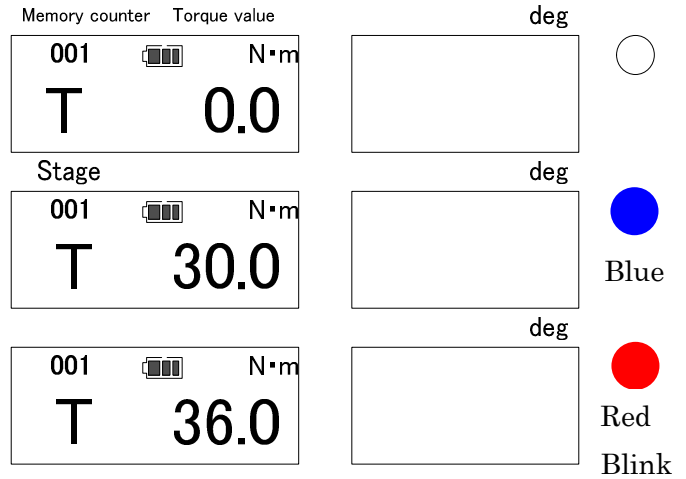

After releasing loading, press MEM key to make judgment whether the tightened torque is within the set range or not. (When auto memory/rest is ON, judgment will be made automatically).

- OK: Saves the measured data and proceed the next tightening.
- NG: A buzzer goes off and the red LED turns on to alarm the operator.

Press MEM key again to save the measured data and proceed the next tightening.

(Press C key to delete the data).

Check the spindle counter (about 0.5 sec)

Tighten the 2nd spindle.

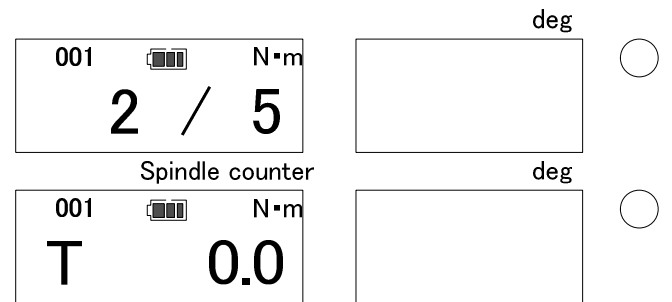

After completing torque tightening for the set number of spindles, proceed to 1st angle tightening stage.

● 1st angle tightening stage

Tighten the 1st angle tightening of the 1st spindle.

After passing the snug torque, the angle counting starts.

Upon reaching the set angle, the buzzer goes off for about 1sec and the blue LED turns on. (Buzzer starts on and off upon reaching 20 degrees from the set angle)

When the tightened angle exceeds the upper limit, Another buzzer goes off and the red LED starts to blink.

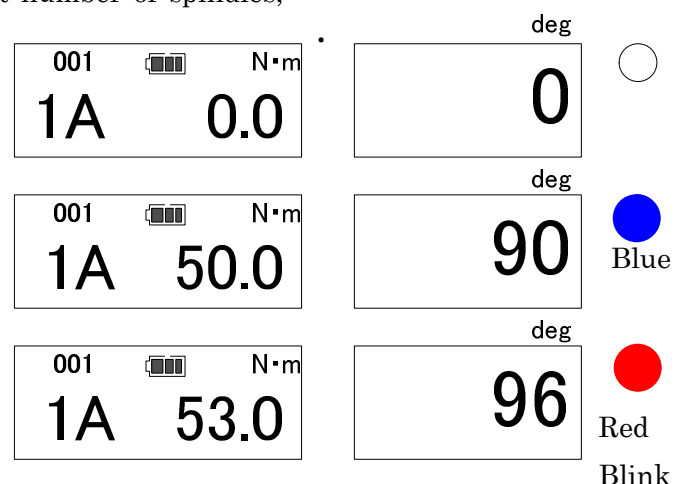

After releasing loading, press MEM to make judgment whether the tightened value is within the set range.

(When auto memory/reset is effective, the judgment will be made automatically) .

- In case of OK: It saves the measured data and proceed to the next counter.
- In case of NG: It informs by the buzzer alarming and the red LED.

Press MEM key again to save this measured data and proceed to the next counter.

If you would like to delete the data, press C key.

Check the spindle counter (about 0.5 sec)		<div style="text-align: right;">deg</div> <div style="border: 1px solid black; width: 100%; height: 100%;"></div>	<input type="radio"/>
Proceeds to 1 st angle tightening of the 2 nd spindle.	<div style="text-align: center;">Spindle counter</div>	<div style="text-align: right;">deg</div> <div style="border: 1px solid black; width: 100%; height: 100%;"></div>	<input type="radio"/>
After completing 1 st angle tightening for the set number of spindles, it proceeds to the 2 nd angle tightening.		<div style="text-align: right;">deg</div> <div style="border: 1px solid black; width: 100%; height: 100%; text-align: center; vertical-align: middle;">0</div>	<input type="radio"/>

● 2nd angle tightening stage

Start 2nd angle tightening of the 1st spindle.

After completing tightening for the set number of spindles, the display changes to the data output display.

● Data output

Press MEM key to complete tightening.
(If the communication cable is connected, it output 1 data at the same time).

	<div style="text-align: right;">deg</div> <div style="border: 1px solid black; width: 100%; height: 100%;"></div>	<input type="radio"/>
--	---	-----------------------

Memory counter will proceed to the next tightening.

	<div style="text-align: right;">deg</div> <div style="border: 1px solid black; width: 100%; height: 100%;"></div>	<input type="radio"/>
--	---	-----------------------

(4) Tightening operation: Example 2 (no torque tightening stage, NG setting: ALLRES)

Below instructions show an operation flow for tightening at the following values.

Tightening torque	0 N·m	2nd tightening angle upper limit	95 deg
Tightening torque upper limit	0 N·m	3rd tightening angle	0
Snug torque	30 deg	3rd tightening angle upper limit	0
1st tightening angle	90 deg	Number of spindles	5pc
1st tightening angle upper limit	95 deg	NG setting	ALLRES
2nd tightening angle	90 deg		

Operation Flow

1st angle tightening stage (5 spindles) → 2nd angle tightening stage (5 spindles)

After completing all the stages, it outputs data and proceed to the next work.

If there is NG in the process, it starts from the beginning stage (NG data remains).

* If you set 0 for tightening torque, it starts from 1st angle tightening.

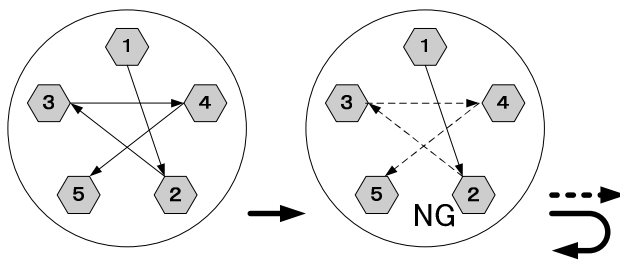

1st angle tightening stage 2nd angle tightening stage

NG: Starts from the beginning stage

(All tightening OK: To next work)

Tightening order →

1st angle tightening stage: Spindle① → Spindle② → Spindle③ → Spindle④ → Spindle⑤ →

2nd angle tightening stage: Spindle① → Spindle② → Start over

NG setting explanation

“NG_RES”:

When the judgment is NG, press MEM key to save the data and proceed to the next spindle.

“ALLRES”:

When the judgment is NG, press MEM key to save the data and the memory counter will be renewed and start from the beginning stage.

* In both cases, press C key to delete the data

Operation and display

● 1st angle tightening stage

Tighten 1st angle tightening of the 1st spindle.

When it passes the snug torque, the display changes to the angle counting.

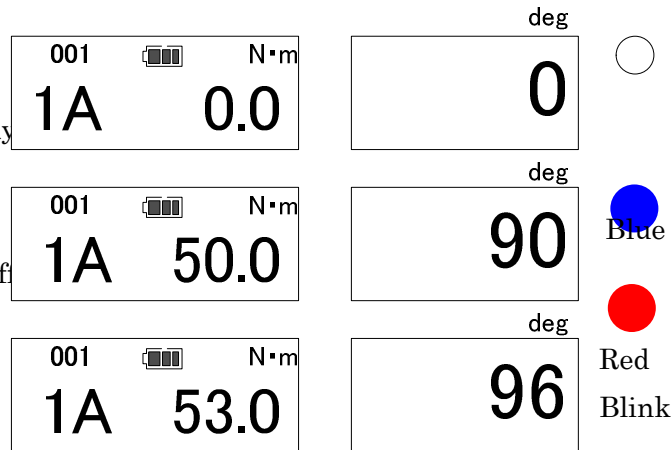

Upon reaching the set angle, the buzzer goes off and the blue LED turns on.

Buzzer starts on and off upon reaching 20 degrees from the set angle).

If the tightened angle exceeds the upper limit, another buzzer goes off and the red LED starts to blink.

After releasing loading, press MEM key to make judgment to see whether the tightened torque/angle is within the set range (The judgment will be made automatically when auto memory/reset is set).

- In case of OK: It saves the measured data and proceed to the next counter.

- In case of NG: It inform by the buzzer alarming and the red LED.

Press MEM key again to save this measured data and proceed to the next counter.

* If you would like to delete the data, press C key.

Check the number of spindles (about 0.5 sec)

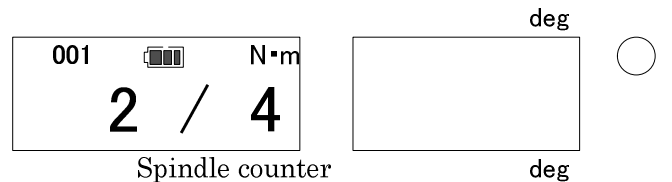

Tighten 1st angle of the 2nd spindle.

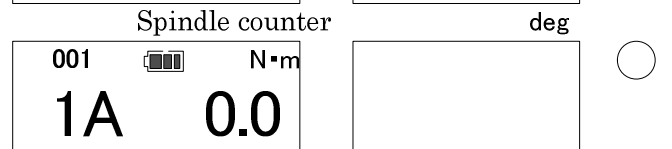

After completing 1st angle tightening for all the number of spindles, it proceeds to the 2nd angle tightening.



● 2nd angle tightening stage

Process 2nd angle tightening of the 1st spindle.

After completing 2nd angle tightening for all the number of spindles, the display shows the data output display.

● Data output

Press MEM key to complete tightening.
 (If the communication cable is connected, it work data at the same time)



Memory counter proceeds to the next work of tightening.

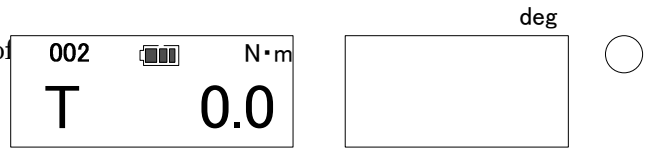

(5) Reading the measured data

Measured data cannot be read out on the display of CTA2-G itself. Transfer the data to PC or printer to see the data.

(6) Output/Delete measured data

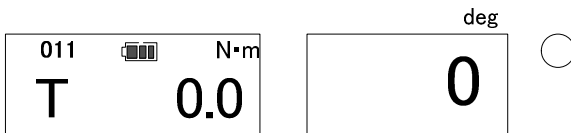

In PEAK mode, press MD key, then it turns to 1 work data output display (below).



Press MEM key to process the data output of the last tightened work.

Press MD key to turn to all data output display.

Press C key to return to measuring condition



Press MEM to process all data output.

Press MD to turn to 1 work data deletion display.

Press C key to return to measuring condition.



Press MD key and C key at the same time to process 1 work data deleting.

Press MD key to turn to all data deletion display.

Press C key to returns to measuring condition.



Press MD key and C key at the same time to process all data deleting.

After deletion, press MD key or C key to return to the measuring condition.

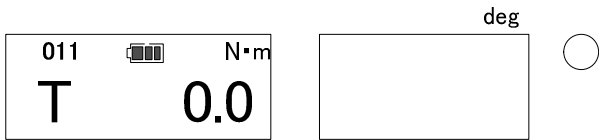

8. Various settings (using the key operation on CTA2-G)

CTA2-G requires mode/parameter setting according to customer usage.

Setting can be done through the enclosed application software (refer to its operation manual) or the key operation on CTA2-G itself.

○ Single-spindle tightening mode

1. Setting items

	Setting items	Display	Default	Alternative selection
1	Tightening torque	SEL		MODE-S,MODE-P
2	Measurement Unit	USEL	N·m	kgf·cm/kgf·m/lbf·in/lbf·ft
3	Snug torque	Sng	0	Below max torque
4	Tightening angle	An	0	Below 999
5	Tightening angle upper limit	AN_H	0	Below 999
6	Tightening direction	tUrn	CW	CCW
7	Auto memory/reset timer	Ar	0	0.0, 0.1~5.0
8	Buzzer	bU	ON	OFF
9	Auto power off	PoFF	3min	10min,30min,NONE
10	External output mode	do	PC	PRN
11	Baud rate	bpS	9600	2400, 4800, 19200
12	Data length	dL	8bit	7bit
13	Parity	Prt	Even	None, Odd
14	Default	dFLt	DFLT-N	DFLT-Y
15	Time (h/m/s)	rtC1		----
16	Date (y/m/d)	rtC2		----

* Tightening mode and date/time will not be initialized even with the 13 Default setting.

* Production tightening mode (P37)

* For setting through the application software (PC), refer to the instruction manual enclosed inside the application CD.

2. Setting by the key operation on CTA2-G (Single-spindle tightening mode).

● RUN mode

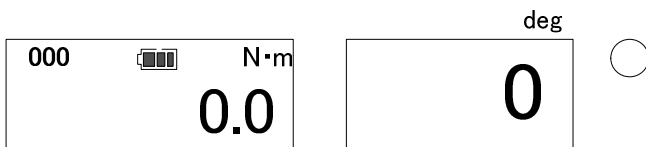

Press MD key for more than 2 sec. After the display changes to tightening mode setting, release the key.

* If it is in production tightening mode, you must press the reset switch or unplug/plug the

recharging terminal to set it to RUN measuring mode.

* In single-spindle tightening mode, use ▲▼ key to set the counter to 000 for RUN mode.

● Tightening mode setting (Default: MODE-S)

Select the tightening mode.

MODE-S: Single-spindle tightening, MODE-P: Production tightening

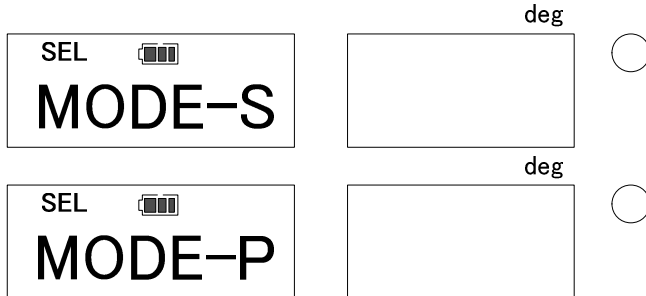

Single-spindle tightening: Set the snug torque and tightening angle to conduct the angle method tightening from the snug torque to the set angle.

Production tightening: Set the snug torque, tightening torque, 1st, 2nd, and 3rd tightening angle, and the number of spindles to conduct the angle method tightening for a series of work on the registered conditions.

Use ▲▼ key to select the mode and press MEM key to confirm. After confirmation, the display turns to Data Clear (Press MD key to proceed without saving. Press C key to return to RUN measuring mode).

● Setting measurement unit (Default: N · m)

Select the torque unit (N · m / kgf · cm / kgf · m / lbf · in / lbf · ft)

The measured torque and the set torque will be converted into the selected torque unit.

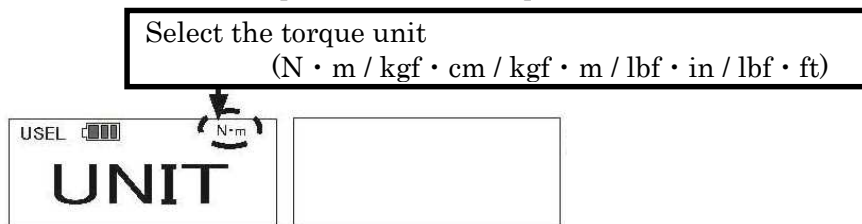

Use ▲▼ key to select the torque unit and press MEM key to save and proceed to the next.

(If you press MD key, it proceeds without saving. If you press C key, it returns to RUN measurement mode).

Unit conversion table	
	Conversion factors
N · m → kgf · cm	10.1972
N · m → kgf · m	0.101972
N · m → lbf · in	8.8508
N · m → lbf · ft	0.73756

Rounding of the converted figures
 $100.0[\text{N} \cdot \text{m}] \times 0.73756 = 73.756 \doteq 73.8[\text{lbf} \cdot \text{ft}]$
 $73.8[\text{lbf} \cdot \text{ft}] \div 0.73756 = 100.05 \doteq 100.1[\text{N} \cdot \text{m}]$
 *Converted figures are rounded as above.
 Accordingly, the resulted figures may have a margin of errors

*Unit conversion is made based on N · m values with the above conversion factors.
 *All the memory and torque setting values are converted when making a unit change.

● Data clear

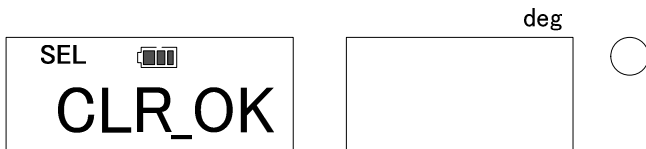

Press MEM to save the tightening mode and proceed to next. (Press C key to return to tightening mode setting.)

* If you change the tightening mode, tightened data will be deleted. Transfer the necessary data to PC or Printer in advance.



(Data clearance display)

● Snug torque setting (Default : 0)

Set the snug torque. This is the torque from which the angle tightening starts to count.

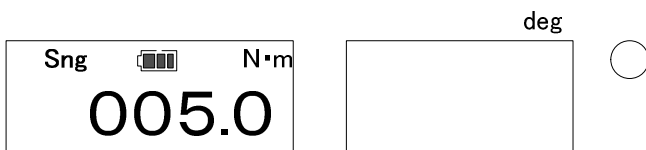

Use ▲ key to select the digit, and change values with ▼ key. Press MEM key to confirm and proceed to the next (Press MD key to proceed without saving. Press C key to return to RUN measuring mode).

● Tightening angle setting (Default : 000)

Set the tightening angle (the angle starting from the snug torque to the final tightening angle).



Use ▲ key to select the digit, and change values with ▼ key. Press MEM key to confirm and proceed to the next (Press MD key to proceed without saving. Press C key to return to RUN measuring mode).

● Tightening angle upper limit setting (Default: 000)

Set the upper angle limit counting from the snug torque.

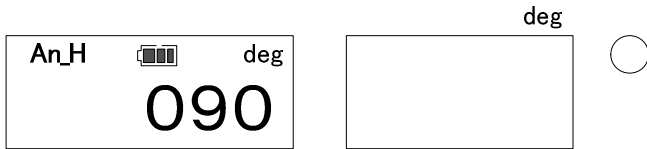

Use ▲ key to select the digit, and change values with ▼ key. Press MEM key to confirm and proceed to the next (Press MD key to proceed without saving. Press C key to return to RUN measuring mode).

● Tightening direction setting (Default: CW)

Set the tightening direction (clockwise/counterclockwise).



Use ▲▼ key to select and MEM key to confirm and proceed to the next.
(Press MD to proceed without saving. Press CD to return to RUN measuring mode).

● Auto memory/reset timer setting (Default: 0.0)

Set the auto memory/reset timer.

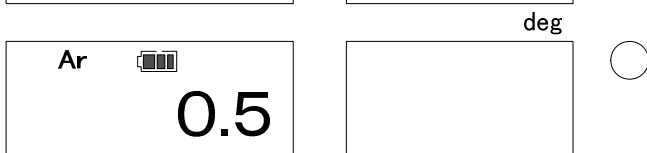
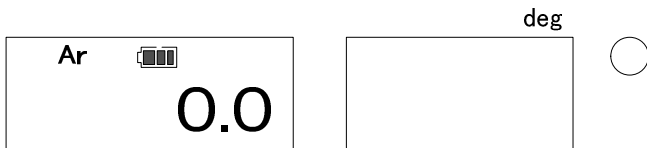

If you prefer not to use auto memory/reset timer, set the value to 0.0.



Use ▲▼ key to change values and MEM key to confirm and proceed to the next.
(Press MD key to proceed without saving. Press C key to return to RUN measuring mode.)

● Buzzer setting (Default: ON)

Select whether or not to apply buzzer sound for each key operation. The buzzer for tightening completion cannot be changed.

bU  ON	deg <input type="checkbox"/>
bU  OFF	deg <input type="checkbox"/>

Use ▲▼ key to select, and MEM key to confirm and proceed to the next.

(Press MD key to proceed without saving. Press C key to return to RUN measuring mode.)

● Auto power off timer setting (Default: 3 min.)

Select from 3MIN, 10MIN, 30MIN, NONE for auto power off timer.

CTA2-G automatically turns off when there is no key operation or loading for the selected time.



If you select NONE, CTA2-G stays on until the battery runs out or power off.

OFF  3 MIN	deg <input type="checkbox"/>
OFF  10 MIN	deg <input type="checkbox"/>
OFF  30 MIN	deg <input type="checkbox"/>
OFF  NONE	deg <input type="checkbox"/>

Use ▲▼ key to select and MEM key to confirm and proceed to the next.

(Press MD key to proceed without saving. Press C key to return to RUN measuring mode.)

● External output communication setting (Default: PC)

do  PC	deg <input type="text"/>	<input type="radio"/>
do  Prn	deg <input type="text"/>	<input type="radio"/>

Select the external output format (PC: PC output / Prn : printer output)

Use ▲▼ key to select and MEM to confirm and proceed to the next.

(Press MD key to proceed without saving. Press C key to return to RUN measuring mode.)





* For external output format, refer to 9. External output for details.

● External output baud rate setting (Default : 9600 bps)

Set the baud rate for external output (2400bps/ 4800bps/ 9600bps/ 19200bps)

* When connected to EPP16M2 (Tohnichi printer), set the baud rate to 2400 bps).

* When connected to PC, set the baud rate to match the baud rate on PC.

bPS  2400	deg <input type="text"/>	<input type="radio"/>
bPS  4800	deg <input type="text"/>	<input type="radio"/>
bPS  9600	deg <input type="text"/>	<input type="radio"/>
bPS  19200	deg <input type="text"/>	<input type="radio"/>

Use ▲▼ key to select and MEM key to confirm and proceed to the next.



(Press MD key to proceed without saving. Press C key to return to RUN measuring mode.)

● External output data length (Default: 8 bit)

Select the communication data length (7bit / 8bit)

* Select 8bit when using the included USB cable (#584).

* Select 7bit when outputting data to EPP16M2 Tohnichi printer.

dL  7BIT	deg <input type="text"/>	<input type="radio"/>
dL  8BIT	deg <input type="text"/>	<input type="radio"/>

Use ▲▼ key to select and MEM key to confirm and proceed to the next.



(Press MD key to proceed without saving. Press C key to return to RUN measuring mode.)

● External output parity setting (Default: EVEN)

Set the parity for external output (EVEN / ODD / NONE)

* When connected to EPP16M2 Tohnichi printer, select NONE.

* When connected to PC, set the same parity as the PC setting.



Prt  NONE	deg <input type="text"/>	<input type="radio"/>
Prt  ODD	deg <input type="text"/>	<input type="radio"/>
Prt  EVEN	deg <input type="text"/>	<input type="radio"/>

Use ▲▼ key to select and MEM key to confirm and proceed to the next.

(Press MD key to proceed without saving. Press C key to return to RUN measuring mode.)

● Reset to the default setting

You can reset all the setting (except tightening mode and time setting) to the default setting.



 dFLt DFT-N	<input type="text"/>	deg <input type="radio"/>
 dFLt DFT-Y	<input type="text"/>	deg <input type="radio"/>

Use ▲▼ key to select DFT-Y to reset to the default setting.

If you would not like to reset, select DFT-N and press MEM key.

(Press MD key to proceed without saving. Press C key to return to RUN measuring mode.)

● Time setting (date / time)

 rtC1 12:59:59	<input type="text"/>	deg <input type="radio"/>
 rtC2 08.12.31	<input type="text"/>	deg <input type="radio"/>

Use ▲▼ key to select time (hour/minute/second) or date.

(Press MD key or C key to return to RUN measuring mode).

● Time setting (hour / minute / second)

 rtC1 12:59:59	<input type="text"/>	deg <input type="radio"/>
--	----------------------	------------------------------

Use ▲▼ key to select hour and MEM to confirm and proceed to the next.

(Press MD key to proceed without saving. Press C key to return to RUN measuring mode.)

 rtC1 12:59:59	<input type="text"/>	deg <input type="radio"/>
--	----------------------	------------------------------

In the same way, select minute and confirm by MEM key.

(Press MD key to proceed without saving. Press C key to return to RUN measuring mode.)



For second setting, press MEM key to reset second counting to 00..

(Press MD key to proceed without saving. Press C key to return to RUN measuring mode.)

● Time display

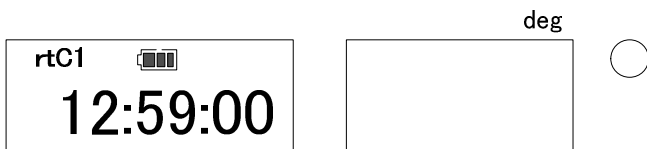

(Press MD key to proceed without saving. Press C key to return to RUN measuring mode.)

● Year/Month/Date setting

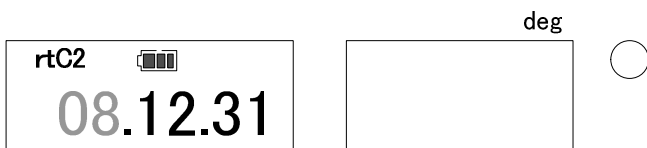

Use ▲▼ key to select Year and MEM to confirm and proceed to the next.

In the same way, select and confirm month and date.

(Press MD key to proceed without saving. Press C key to return to RUN measuring mode.)

○ Production tightening mode

1. Setting items

	Setting items	Display	Default	Alternative selection
1	Tightening mode	SEL		MODE-S、MODE-P
2	Measurement Unit	USEL	N·m	kgf·cm/kgf·m/lbf·in/lbf·ft
3	Tightening torque	SE	0	Below max torque
4	Tightening torque upper limit	SE_H	0	Below max torque
5	Snug torque	Sng	0	Below max torque
6	1 st tightening angle	An1	0	Bellow 999
7	1 st tightening angle upper limit	A1_H	0	Below 999
8	2 nd tightening angle	An2	0	Below 999
9	2 nd tightening angle upper limit	A2_H	0	Below 999
10	3 rd tightening angle	An3	0	Below 999
11	3 rd tightening angle upper limit	A3_H	0	Below 999
12	Spindle number	n	1	Below 999
13	NG setting	ng	NG_RES	AL_RES
14	Tightening direction	tUrn	CW	CCW
15	Auto memory/reset timer	Ar	0.0	0.0, 0.1 - 5.0
16	Buzzer	bU	ON	OFF
17	Auto power off timer	PoFF	3min	10min, 30min, NONE
18	External output mode	do	PC	PRN
19	Baud rate	bpS	9600	2400, 4800, 19200
20	Data length	dL	8bit	8bit
21	Parity	Prt	Even	None, Odd
22	Default	dFLt	DFLT-N	DFLT-Y
23	Time (h/m/s)	rtC1	None	----
24	Date (y/m/d)	rtC2	None	----

* Default function (21) does not initialize the tightening mode and time and date.

* Single Spindle Tightening mode setting (P28)

* For setting though the application software (PC), refer to the instruction manual enclosed inside the application CD.

2. Setting by key operation on CTA2-G.

● RUN mode

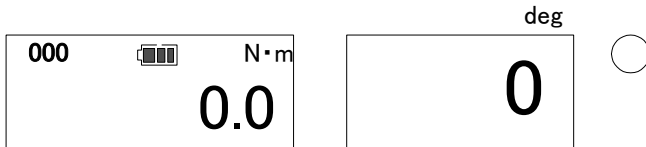

Press MD key for more than 2 sec. After the display changes to tightening mode setting, release the key.

- * If it is in production tightening mode, you must press the reset switch or unplug/plug the recharging terminal to set it to RUN measuring mode.
- * In single-spindle tightening mode, use ▲▼ key to set the counter to 000 for RUN mode.

● Tightening mode setting (Default: MODE-S)

Select the tightening mode.

MODE-S: Single-spindle tightening, MODE-P: Production tightening

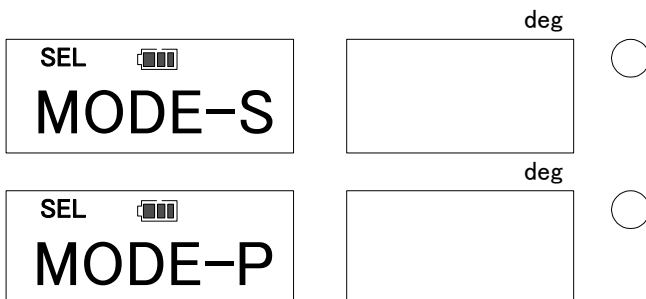

Single-spindle tightening: Set the snug torque and tightening angle to conduct the angle method tightening from the snug torque to the set angle.

Production tightening: Set the snug torque, tightening torque, 1st, 2nd, and 3rd tightening angle, and the number of spindles to conduct the angle method tightening for a series of work on the registered conditions.

Use ▲▼ key to select the mode and press MEM key to confirm. After confirmation, the display turns to Data Clear check (Press MD key to proceed without saving. Press C key to return to RUN measuring mode).

● Data Clear check



Press MEM to save the tightening mode and proceed to next. (Press C key to return to tightening mode setting.)

* If you change the tightening mode, tightened data will be deleted. Transfer the necessary data to PC or Printer in advance.



● Setting measurement unit (Default: N · m)

Select the torque unit (N·m/kgf·cm/kgf·m/lbf·in/lbf·ft)

The measured torque and the set torque will be converted into the selected torque unit.

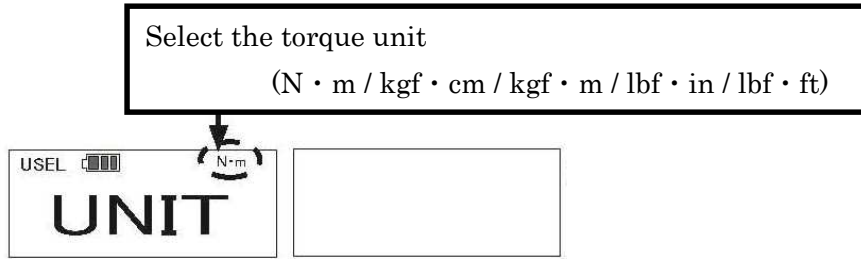

Use ▲▼key to select the torque unit and press MEM key to save and proceed to the next. (If you press MD key, it proceeds without saving. If you press C key, it returns to RUN measurement mode).

Unit conversion table	
	Conversion factors
N·m → kgf·cm	10.1972
N·m → kgf·m	0.101972
N·m → lbf·in	8.8508
N·m → lbf·ft	0.73756

Rounding of the converted figures
 $100.0[\text{N} \cdot \text{m}] \times 0.73756 = 73.756 \approx 73.8[\text{lbf} \cdot \text{ft}]$
 $73.8[\text{lbf} \cdot \text{ft}] \div 0.73756 = 100.05 \approx 100.1[\text{N} \cdot \text{m}]$
 *Converted figures are rounded as above.
 Accordingly, the resulted figures may have a margin of errors

*Unit conversion is made based on N · m values with the above conversion factors.
 *All the memory and torque setting values are converted when making a unit change.

● Tightening torque setting (Default: 0)

Set the torque value of the torque tightening stage.

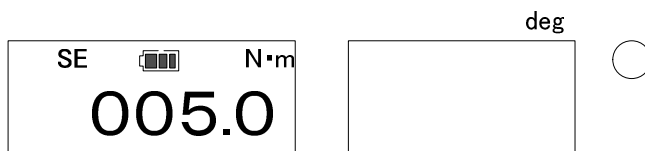

Use ▲ key to select the digit, and ▼ key to change the value. Press MEM key to confirm and proceed to the next.

(Press MD to proceed without saving. Press C key to return to RUN measuring mode).

● Tightening torque upper limit setting (Default: 0)

Set the tightening torque upper limit.

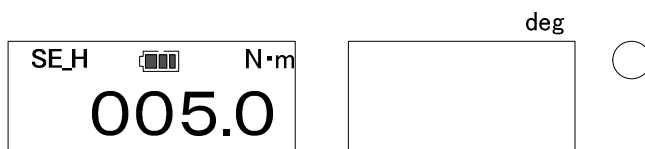

Use ▲ key to select the digit, and ▼ key to change the value. Press MEM key to confirm and proceed to the next.

(Press MD to proceed without saving. Press C key to return to RUN measuring mode).

● Snug torque setting (Default: 0)

Set the snug torque. This is the torque from which the angle tightening count starts.

(It is recommended that snug torque should be set at the same as the tightening torque or lower.)

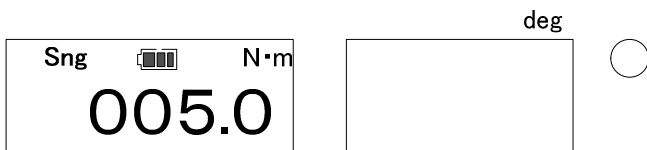

Use ▲ key to select the digit, and ▼ key to change the value. Press MEM key to confirm and proceed to the next.

(Press MD to proceed without saving. Press C key to return to RUN measuring mode).

● 1st angle setting (Default: 0)

Set 1st tightening angle.



Use ▲ key to select the digit, and ▼ key to change the value. Press MEM key to confirm and proceed to the next.

(Press MD to proceed without saving. Press C key to return to RUN measuring mode).

● 1st angle upper limit setting (Default: 0)

Set the 1st angle tightening upper limit.



Use ▲ key to select the digit, and ▼ key to change the value. Press MEM key to confirm and proceed to the next.

(Press MD to proceed without saving. Press C key to return to RUN measuring mode).

● 2nd angle setting (Default: 0)

Set the 2nd tightening angle.



Use ▲ key to select the digit, and ▼ key to change the value. Press MEM key to confirm and proceed to the next.

(Press MD to proceed without saving. Press C key to return to RUN measuring mode).

*If there is no 2nd angle tightening stage, set the value to 000, then it proceeds to number of spindles setting.

● 2nd angle upper limit setting (Default: 0)

Set the 2nd tightening angle upper limit.

A2_H		deg		deg	<input type="radio"/>
100					

Use ▲ key to select the digit, and ▼ key to change the value. Press MEM key to confirm and proceed to the next.

(Press MD to proceed without saving. Press C key to return to RUN measuring mode).

● 3rd angle setting (Default: 0)

Set the 3rd tightening angle.

An3		deg		deg	<input type="radio"/>
090					

Use ▲ key to select the digit, and ▼ key to change the value. Press MEM key to confirm and proceed to the next.

(Press MD to proceed without saving. Press C key to return to RUN measuring mode).

*If there is not 3rd angle tightening stage, set the value to “000”, then it proceeds to number of spindle setting.

● 3rd angle upper limit setting (Default: 0)

Set the 3rd angle upper limit.

A3_H		deg		deg	<input type="radio"/>
100					

Use ▲ key to select the digit, and ▼ key to change the value. Press MEM key to confirm and proceed to the next.

(Press MD to proceed without saving. Press C key to return to RUN measuring mode).

● Number of spindle setting (Default: 01)

Set the number of spindles.

n				deg	<input type="radio"/>
01					

Use ▲▼ key to select the digit, and press MEM key to confirm and proceed to the next.

(Press MD to proceed without saving. Press C key to return to RUN measuring mode).

● Data Clear Check

n  CLR_OK	deg <input type="text"/>	<input type="radio"/>
--	-----------------------------	-----------------------

Press MEM key to save the number and proceed to the next.

Press C key to return to tightening mode setting.



* If you change the number of spindles, tightening data will be deleted. Output the Necessary data to PC or printer in advance.

n  CLEAR	deg <input type="text"/>	<input type="radio"/>
---	-----------------------------	-----------------------

(Data Clear display)

● NG setting (Default: NG_RES)

Select from two options (NG_RES / AL_RES) in case the judgment for tightening torque/angle is NG.

ng  NG_RES	deg <input type="text"/>	<input type="radio"/>
ng  AL_RES	deg <input type="text"/>	<input type="radio"/>

NG_RES : When the judgment is NG, press MEM to save the tightening data, and proceed to the next tightening (If you press Clear key, the tightening data will be deleted and it will be set for the same spindle tightening).

AL_RES : When the judgment is NG, press MEM to save all the tightening data of the work and re-start from the beginning stage.

Use ▲▼ key to select NG setting and press MEM key to confirm and proceed to the next.

(Press MD to proceed without saving. Press C key to return to RUN measuring mode).

The remaining settings (tightening direction, thereafter) is the same as the instructions for single-spindle tightening. Please refer to P30 -.

9. Various settings (using the application software)

CTA2-G requires mode/parameter setting according to customer usage.

Setting can be done through the enclosed application software or the key operation on CTA2-G itself (P28).

① Install the enclosed application software and the USB driver to PC (Refer to the instruction manual on the CD for installing method. Connect CTA2-G and PC with the dedicated communication cable (No.584). Make the same communication settings (baud rate, data length, parity) on CTA2-G and the PC at parameter setting.

② Turn on CTA2-G and start application software, communication will be established. In case of connection troubles, check followings.

-Installation of USB driver

-Connecting cable

-Power status of CTA2-G

-Parameter settings of CTA2-G and application software

③ Check the current settings

- Select "Single Mode" or "Production Mode" and click

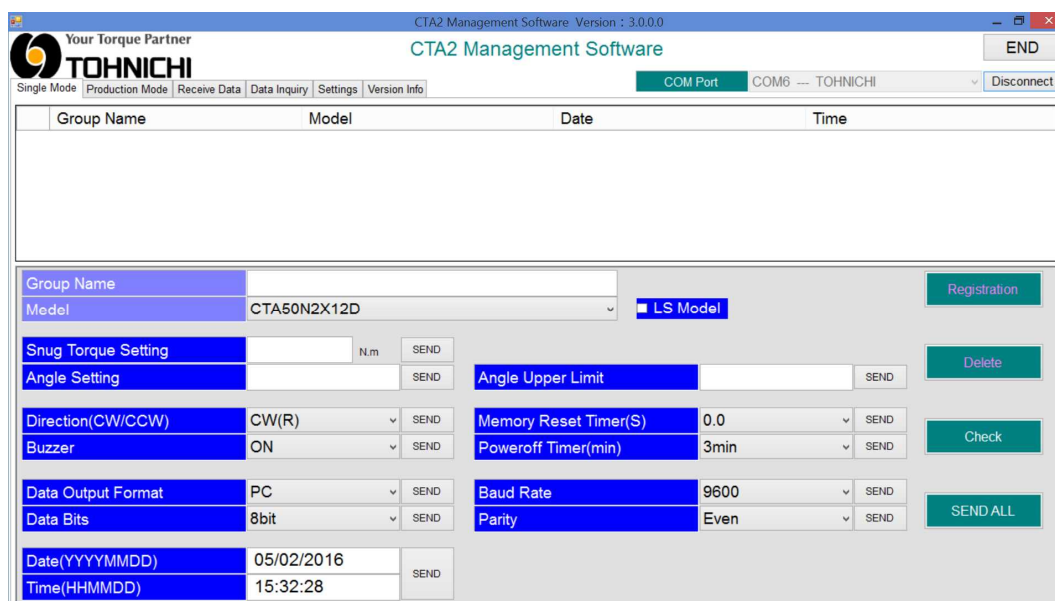

Setting (no registration)

- Turn on CTA2-G. Click "Check" on the PC and the current settings will be transferred to PC for checking.

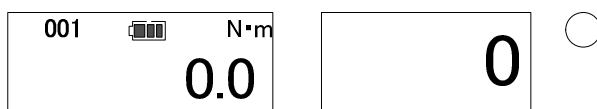

Measurement ready (Single spindle tightening mode)

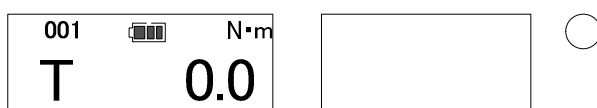

Measurement ready (Production tightening mode)

The screenshot shows the CTA2 Management Software interface. At the top, it displays 'Your Torque Partner TOHNICHI' and 'CTA2 Management Software Version : 3.0.0.0'. The interface includes a menu bar with 'Single Mode', 'Production Mode', 'Receive Data', 'Data Inquiry', 'Settings', and 'Version Info'. A 'COM Port' dropdown is set to 'COM6 -- TOHNICHI'. Below this is a table with columns for 'Group Name', 'Model', 'Date', and 'Time'. The main area contains various settings: 'Group Name' (empty), 'Model' (CTA50N2X12D), 'Unit' (N.m), 'LS Model' (checked), 'Snug Torque Setting' (empty), 'Angle Setting' (empty), 'Angle Upper Limit' (empty), 'Direction(CW/CCW)' (CW(R)), 'Buzzer' (ON), 'Memory Reset Timer(S)' (0.0), 'Poweroff Timer(min)' (3min), 'Data Output Format' (PC), 'Data Bits' (8bit), 'Baud Rate' (9600), 'Parity' (Even), 'Date(YYYYMMDD)' (05/02/2016), and 'Time(HHMMDD)' (15:32:28). Buttons for 'Registration', 'Delete', 'Check', and 'SEND ALL' are visible.

④ Registration of the parameter settings

- To change the parameter settings, fill in values in the corresponding box.
- Type a group name and click “Registration” to register the new settings. This will save all parameter setting for the group.

The screenshot shows the CTA2 Management Software interface with a group registered. The 'COM Port' dropdown is still 'COM6 -- TOHNICHI'. The table now has one entry: 'TOHNICHI001' with 'Model' 'CTA100N2X15D-G', 'Date' '05/02/2016', and 'Time' '15:39:40'. The settings below are: 'Group Name' (TOHNICHI001), 'Model' (CTA100N2X15D-G), 'Unit' (N.m), 'LS Model' (checked), 'Snug Torque Setting' (5.0), 'Angle Setting' (10), 'Angle Upper Limit' (50), 'Direction(CW/CCW)' (CW(R)), 'Buzzer' (ON), 'Memory Reset Timer(S)' (0.0), 'Poweroff Timer(min)' (3min), 'Data Output Format' (PC), 'Data Bits' (8bit), 'Baud Rate' (9600), 'Parity' (Even), 'Date(YYYYMMDD)' (05/02/2016), and 'Time(HHMMDD)' (15:39:40). Buttons for 'Registration', 'Delete', 'Check', and 'SEND ALL' are visible.

Settings

⑤ Transfer new settings to CTA2-G

Turn on CTA2-G and make sure it is connected.

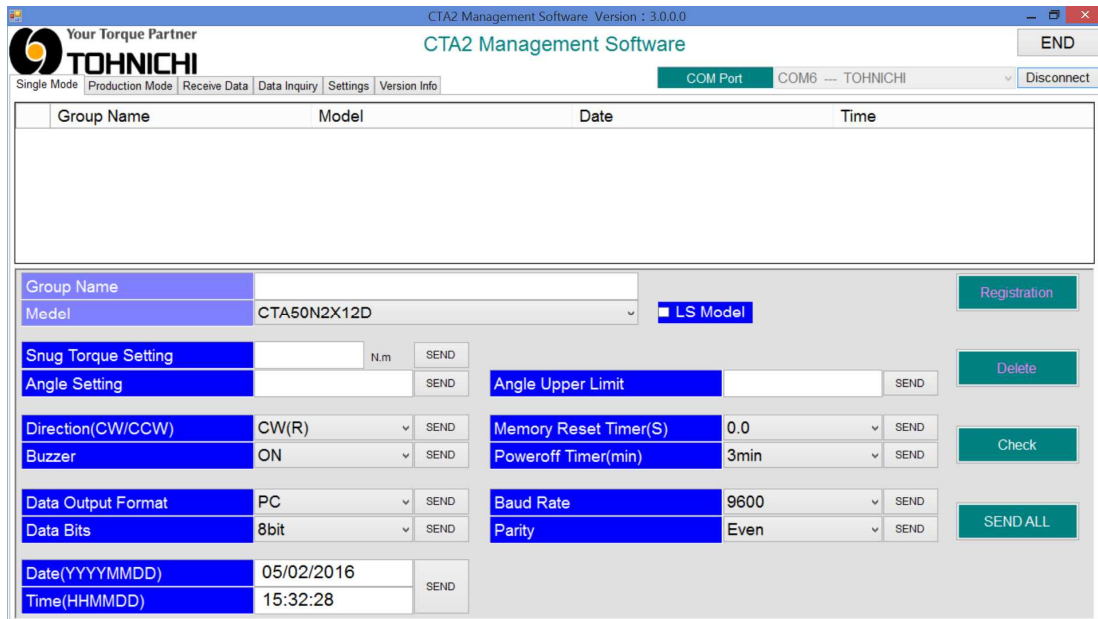

○ Setting all at one time

- To make all the settings at one time.
- Click “SEND ALL” to transfer all the setting values to CTA2-G to overwrite the settings on CTA2-G.

○ Setting one by one

- To set each value of the setting requirements on one by one basis.
- Click “<<SEND” on the particular part which you want to change to overwrite the setting on CTA2-G.

※After transferring the setting, click “Check” to confirm the new settings were received by CTA2-G.

10. Transferring the tightening data to PC

Transfer the tightening data to PC for management.

○ Single Spindle Tightening mode

① Preparation

Install the enclosed application software and the USB driver to PC (Refer to the instruction manual on the CD for installing method). Connect CTA2-G and PC with the dedicated communication cable (No.584). Make the same communication settings (baud rate, data length, parity) on CTA2-G and the PC at parameter setting.

② Turning on CTA2-G and start application software, communication will be established. In case of connection troubles, check followings.

-Installation of USB driver

-Connecting cable

-Power status of CTA2-G

-Parameter settings of CTA2-G and application software

③ Setting the data range to transfer

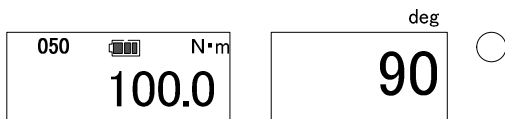

Use ▲▼key to set the memory counter to the upper maximum value of the data range you would like to transfer and press MD key



Use ▲▼key to set the memory counter to the lower minimum value of the data range you want to transfer and press MD. The display turns to the following (sample quantity display).



④ Receiving data

- Select "Receive data" and click "Reception". It starts communication(Waiting).

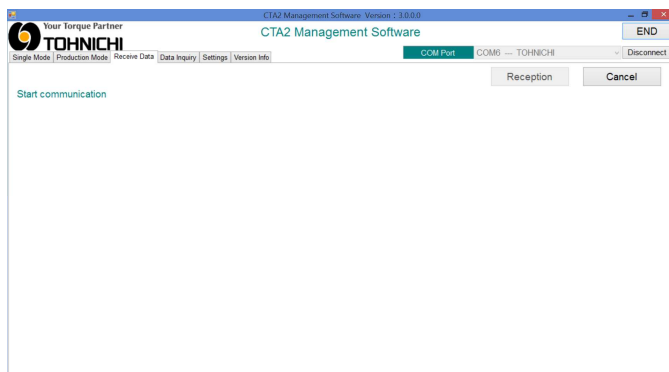

⑤ Transferring data

- Press MEM key on CTA2-G to transfer the data, then the display turns to “Data receiving (receiving)” .

⑥ Checking the received data

- Click “Data Inquiry” on the main menu and select the data file you want to check.

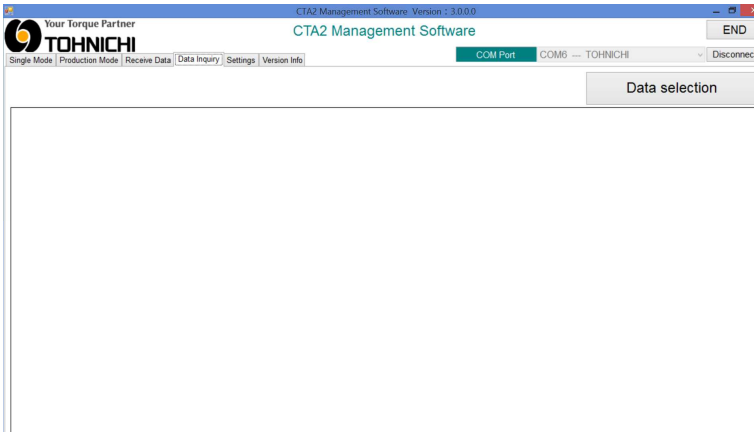

- Click “Data Selection” and open the data.

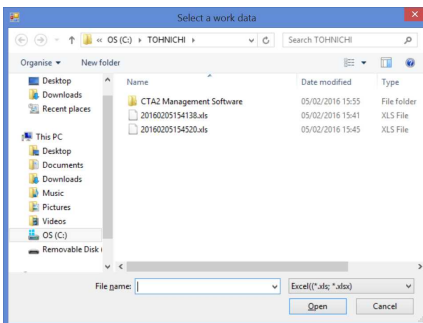

Data file selection

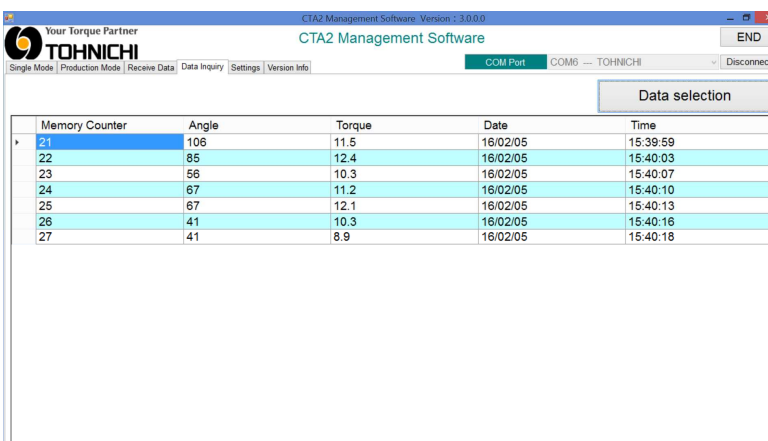

Data inquiry

○Production Tightening Mode

①Preparation

Install the enclosed application software and the USB driver to PC (Refer to the instruction manual on the CD for installing method. Connect CTA2-G and PC with the dedicated communication cable (No.584). Make the same communication settings (baud rate, data length, parity) on CTA2-G and the PC at parameter setting.

②Set CTA2-G ready for data output CTA2-G by pressing the "MD" key in PEAK Mode (any count 001-999) .

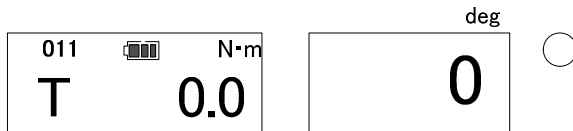

Press MD key at PEAK mode, then it will be set ready for 1 set data output.



Press MD key again to set ready for all data output.



③Waiting to receive data

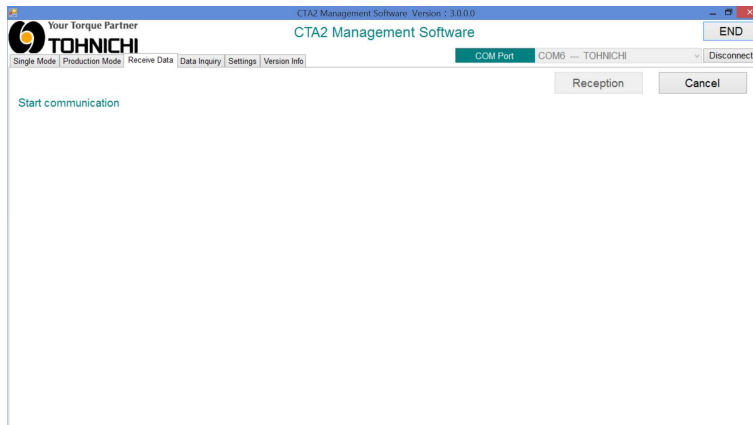

- Select "Receive Data"
- Click "Reception" then, it starts communication(Waiting).

④ Transferring data

Press MEM key on CTA2-G to transfer data

⑤ Checking the received data

- Select “Data Inquiry” section and move to “data file selection”.
- Click “Data selection” and open the data.

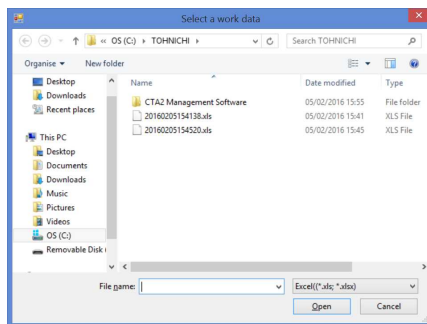
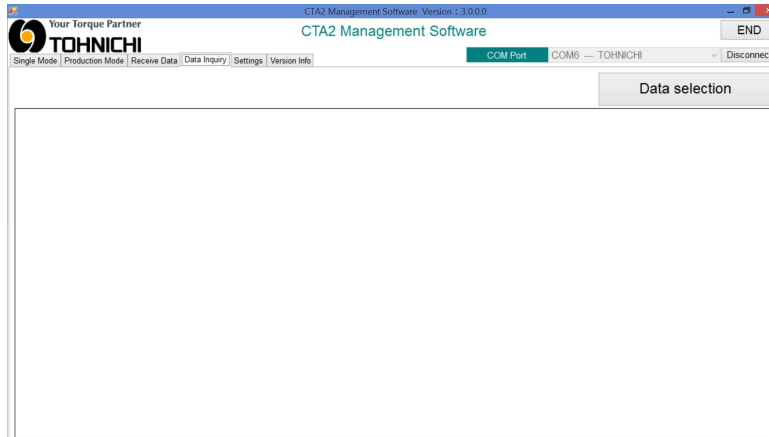

Data file selection

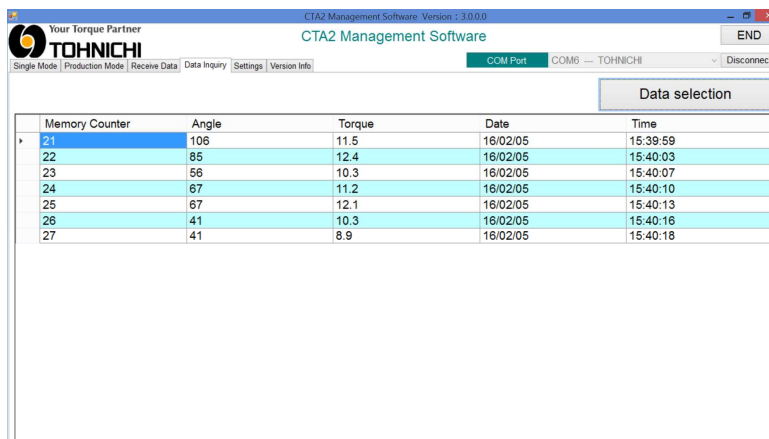

Data inquiry

11. External output

(1) Communication specifications

Synchronous method Start-stop synchronization
 Baud rate 2400/4800/9600/19200bps (Default: 9600bps)
 Data length 7bit/8bit (Default: 8bit)
 Stop bit: 1bit
 Parity EVEN / ODD / NONE (Default: EVEN)

(2) Output to PC

Connect CTA2-G to PC with the dedicated communication cable (No.584).

Set the PC communication settings (baud rate, data length, parity) to correspond to the CTA2-G communication settings.

* If you are using the communication cable (No.584), set the data length to 8bit.

Output format

○ Single-spindle tightening mode

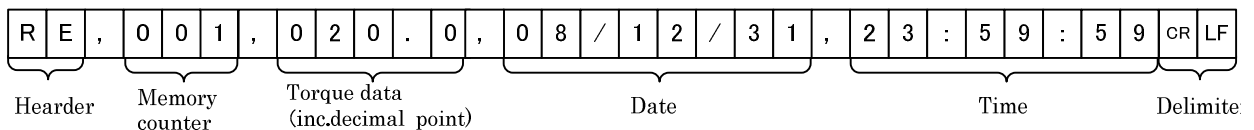
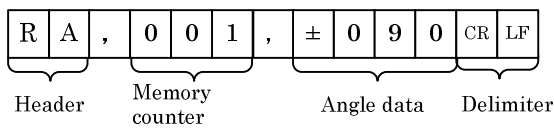

○ Production tightening mode

• Tightening starting data

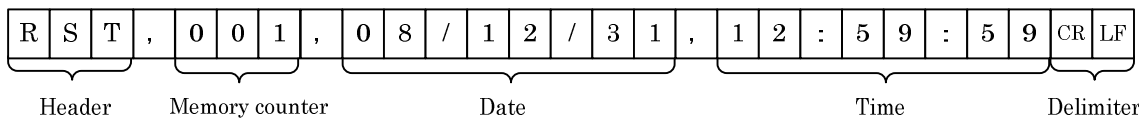

• Tightening torque data

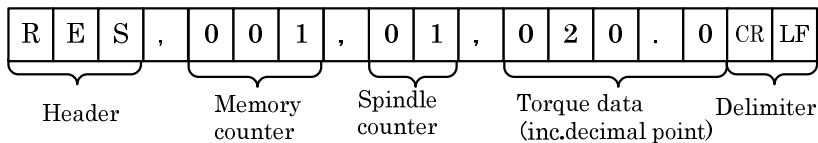

• Angle data

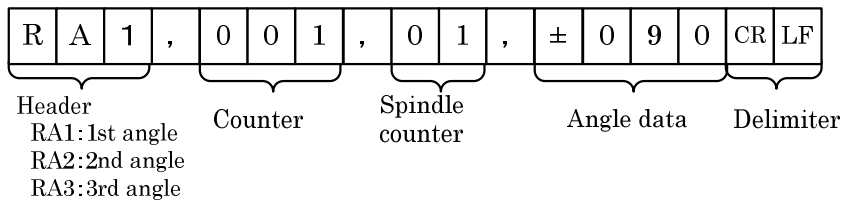

• Final torque

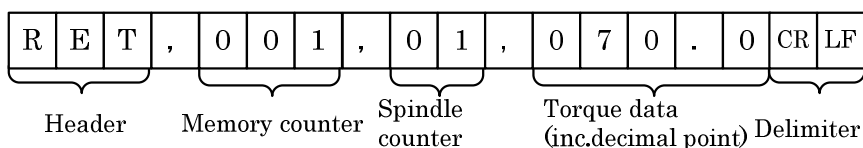

Output image sample of production tightening mode

RST, 001, 08/12/31, 12:59:59CRLF	Tightening starting date and time
RES, 001, 01, 020.0CRLF	
RES, 001, 02, 021.0CRLF	
RES, 001, 03, 020.5CRLF	Torque tightening data
RES, 001, 04, 020.4CRLF	
RES, 001, 05, 020.6CRLF	
RA1, 001, 01, 090CRLF	
RA1, 001, 02, 092CRLF	1st angle tightening data
RA1, 001, 03, 090CRLF	
RA1, 001, 04, 095CRLF	
RA1, 001, 05, 090CRLF	
RA2, 001, 01, 090CRLF	
RA2, 001, 02, 090CRLF	
RA2, 001, 03, 092CRLF	2nd angle tightening data
RA2, 001, 04, 091CRLF	
RA2, 001, 05, 090CRLF	
RET, 001, 01, 065.0CRLF	
RET, 001, 02, 064.0CRLF	
RET, 001, 03, 063.0CRLF	Final torque data
RET, 001, 04, 066.0CRLF	
RET, 001, 05, 065.0CRLF	

(3) Printer output

When connected to EPP16M3 Tohnichi printer, use the dedicated cable (No.575).

CTA2-G communication setting should be changed as follows:

External output format	Prn
Baud rate	2400bps
Data length	7bit
Parity	NONE

○ Single-spindle tightening mode

1: 60.0 N·m 90 deg 12/31 10:00:00	Memory counter: tightening torque and tightening angle Tightening date and time (month/date, h/m/s)
2: 61.0 N·m 92 deg 12/31 10:00:05	
3: 62.0 N·m 91 deg 12/31 10:00:10	

○ Production tightening mode

001: 08/12/31 12:59:59	Memory counter:
1: S 20.0 N·m	Tightening date
: 1A 90 deg	1st spindle tightening data
: 2A 92 deg	tightening torque
: T 65.0 N·m	1st tightening angle
2: S 21.0 N·m	2nd tightening angle
: 1A 92 deg	Final torque
: 2A 90 deg	2nd spindle tightening data
: T 64.0 N·m	
3: S 20.5 N·m	3rd spindle tightening data
: 1A 90 deg	
: 2A 92 deg	
: T 63.0 N·m	
4: S 20.4 N·m	4th spindle tightening data
: 1A 95 deg	
: 2A 91 deg	
: T 66.0 N·m	
5: S 20.6 N·m	5th spindle tightening data
: 1A 90 deg	
: 2A 90 deg	
: T 65.0 N·m	

12. Battery

Battery life

The average battery life is 500 times of charge/discharge depending on the usage conditions.

If battery is old, replace it with new ones (BP-5).

Use BC-3-G charger to charge the battery before use.

The battery is not charged when delivered.

13. Charging

Connect the connector of the charger (BC-3-G) to the charging jack of CTA2-G.

When recharging, the green lamp on the charger turns on. If the battery is empty, it takes about 3.5 hours for full charging.

* The connector of the CTA2-G charger (BC-3-G) is cream color.

The connector of the charger for original CTA is black color.

Caution)

1. Use the rated voltage only.
2. If you keep charging the battery after it is fully charged, it may shorten the battery life. As soon as the green lamp turns on, remove the battery from the charger.
3. You cannot use the product when it is connected to the charger.
4. Under abnormal conditions, the green lamp turns on while the red lamp keeps blinking. If it occurs, stop using immediately, and contact the nearest distributor or Tohnichi for further support.
5. Charge the battery under temperature range of 0 – 40 degrees Celsius.
6. If you should find anything abnormal on the product, stop using immediately and place it in a safe place. Seek further support to Tohnichi.
7. If you are not using the product in a long time, take out the battery to store in a safe place. Even if not in use, charge the battery at least once a year.

14. Option

- | | |
|---|-----------|
| (1) Battery pack | (BP-5) |
| (2) Charger (100~240V) | (BC-3-G) |
| (3) Interchangeable head
(SH,RH,QH,RQH,DH,HH,FH) | |
| * PH interchangeable head cannot be used. | |
| (4) Communication cable | |
| • CEM3-EPP16M3 | (No. 575) |
| • CEM3-PC (D-SUB 9 pin Female) | (No. 575) |
| • CEM3-PC (USB A) | (No. 584) |
| (5) Tohnichi printer | EPP16M3 |

* The battery pack, charger, communication cable dedicated for CTA are not compatible with for CTA2/-G. Only the interchangeable head is compatible.

15. Specifications

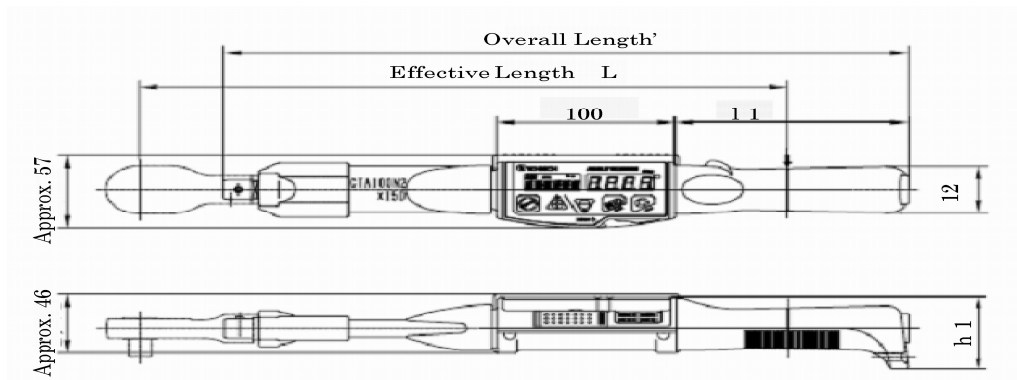

The value () is the minimum snug torque value. The accuracy of the snug torque value which is set below the minimum torque range cannot be guaranteed.

	Single-spindle tightening mode	Production tightening mode
Torque accuracy	±1%	
Angle accuracy	±2° + 1digit (rotating 90 degree at speed of 30-180°/sec)	
Display	7 segment LED 4 digit (character height 10mm)	
	14 segment LCD 6 digit (character height 7mm)	
	7 segment LCD 4 digit (character height 3mm)	
	Judgment LED 2 colors (blue/red)	
	Residual battery indicator (4-step)	
Data quantity	999 readings (tightening, angle, final torque, time)	999 spindle data (tightening torque, 1 st , 2 nd , 3 rd tightening angle, final torque, time)
Basic function	Auto zero (torque, angle)	
	Tightening completion alarm	
	Auto memory/reset	
	Auto power off	
	Over-torque alarm	
	Time	
	OK/NG judgment	
Communication	RS232C compliant (2400-19600bps)	
	USB compliant serial communication	
Continuous use	20 hour (8 hour)	
Charging time	About 3.5 hour (when charged for 1 hour)	
Power source	Nickel hydride battery pack (BP-5)	
Operative temperature range	0 – 40 degree (no condensation)	

Model	Torque Range																			
	N.m				kgf.cm				kgf.m				lbf.in				lbf.ft			
	snug	Min	Max	1digit	sung	Min	Max	1digit	sung	Min	Max	1digit	sung	Min	Max	1digit	sung	Min	Max	1digit
CTA50N2X12D-G	2.5	10	50	0.05	25	100	500	0.5	0.25	1	5	0.005	22.5	100	450	0.5	1.85	7.5	36.5	0.05
CTA100N2X15D-G	5	20	100	0.1	50	200	1000	1	0.5	2	10	0.01	45	200	900	1	3.8	15	75	0.1
CTA200N2X19D-G	10	40	200	0.2	100	400	2000	2	1	4	20	0.02	88	350	1750	2	7.5	30	150	0.2
CTA360N2X22D-G	18	72	360	0.4	180	720	3600	4	1.8	7	36	0.05	159	640	3150	5	13	52	260	0.5
CTA500N2X22D-G	25	100	500	0.5	250	1000	5000	5	2.5	10	50	0.05	220	880	4400	5	18	72	360	0.5
CTA850N2X32D-G	43	170	850	1	-	-	-	-	4.3	17	85	0.1	-	-	-	-	31	124	620	1

Model	Angle Measuring Range		Angle Accuracy	Overall Length [mm]	Weight [kg]	Interchangeable Head
	Min.-Max.	1 digit				
CTA50N2X12D-G	0-999°	1°	±2°+1digit (Angular velocity is 30°/x~180°/s when the bolt turned to 90°)	282	0.58	QH12D
CTA100N2X15D-G				384	0.63	QH15D
CTA200N2X19D-G				475	0.78	QH19D
CTA360N2X22D-G				713	1.13	QH22D
CTA500N2X22D-G				949	4	
CTA850N2X32D-G				1387	5.14	QH32D



TOHNICHI MFG. CO., LTD.

2-12, Omori-Kita 2-Chome, Ota-Ku, Tokyo 143-0016, Japan

TEL:+81-3-3762-2455

FAX:+81-3-3761-3852

E-mail : overseas@tohnichi.co.jp

URL : <http://tohnichi.jp/english/index.html>

N.V. TOHNICHI EUROPE S.A.

Industrieweg 27, Boortmeerbeek, B-3190 Belgium

TEL:+32 16 60 66 61

FAX:+32 16 60 66 75

E-mail : tohnichi-europe@online.be

URL : <http://www.tohnichi.be>

TOHNICHI AMERICA CORP.

1303 Barclay Blvd. Buffalo Grove, IL 60089 USA

TEL:+1 847 947 8560

FAX:+1 847 947 8572

E-mail : inquiry@tohnichi.com

URL : <http://www.tohnichi.com>

TOHNICHI SALES SHANGHAI CO., LTD.

Rm. 5 No. 99 Nong 1919 Du Hui Road Minhang. Shanghai. P. R. China

TEL:+86 21 3407 4008

FAX:+86 21 3407 4135

E-mail : sales@tohnichi-sh.com

URL : <http://www.tohnichi-sh.com/>